



## **2023 PRIMARY 3 END-OF-YEAR EXAMINATION**

Name : \_\_\_\_\_ ( )

Date: 26 October 2023

Class : Primary 3 ( )

Time: 8.00 a.m. - 9.15 a.m.

Duration: 1 hour 15 minutes

# **SCIENCE BOOKLET A**

### **INSTRUCTIONS TO CANDIDATES**

1. Write your name, class and register number.
2. Do not turn over this page until you are told to do so.
3. Follow all instructions carefully.
4. Answer all questions.
5. Shade your answers on the Optical Answer Sheet (OAS) provided.



**Booklet A (17 x 2 marks)**

For each question from 1 to 17, four options are given. One of them is the correct answer. Make your choice (1, 2, 3 or 4) and shade your answer on the Optical Answer Sheet.

(34 marks)

1. The pictures below show some characteristics of living things. Which of the following shows that living things can respond to changes?

(1) A hen lays eggs in a nest.



(2) A baby becomes a boy over five years.

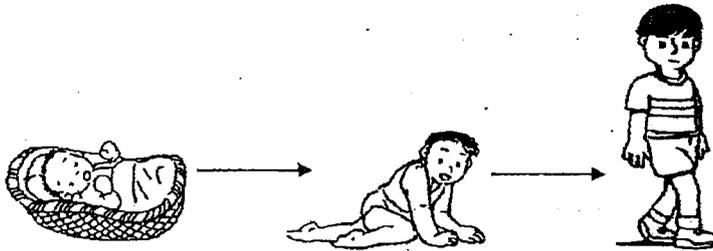

(3) A bird feeds on the nectar of a flower.

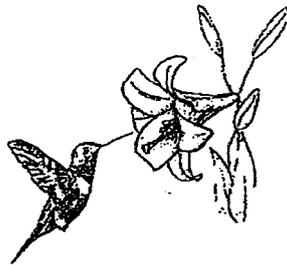

(4) A tortoise hides in its shell when touched.

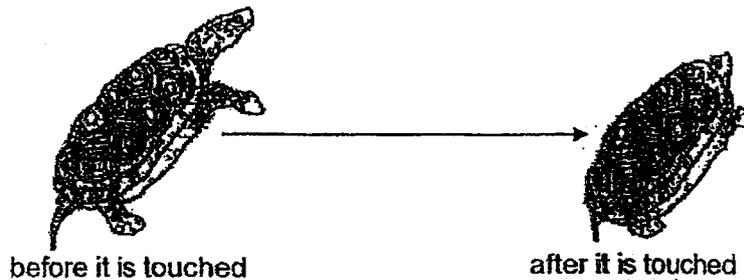

2. Ken conducted an experiment using four set-ups as shown below.

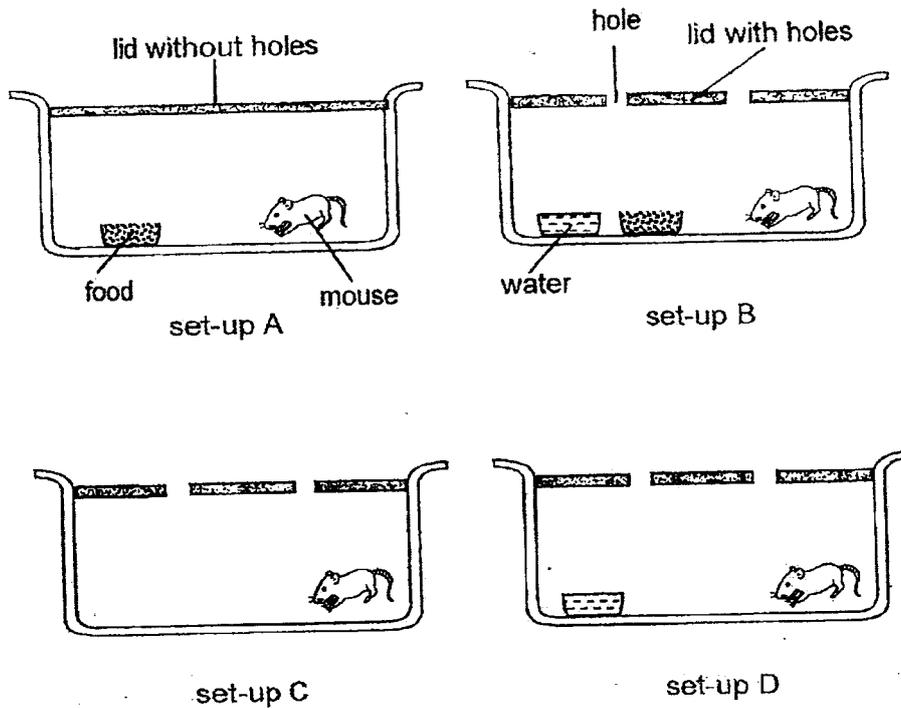

Which two set-ups should he use to find out if living things need food to survive?

- (1) A and D
- (2) B and C
- (3) A and C
- (4) B and D

3. Study the pictures below.

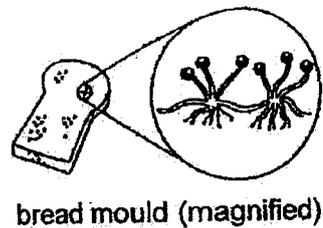
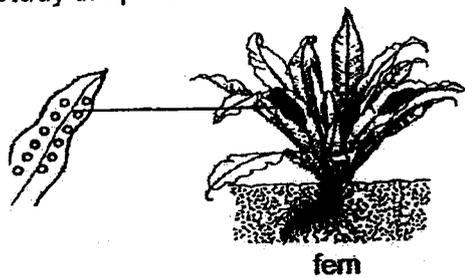

Which statement about the bread mould and the fern is correct?

- (1) Both produce flowers.
- (2) Both make their own food.
- (3) Both need sunlight to grow.
- (4) Both reproduce from spores.

4. Jane grouped some animals into Group E and Group F as shown below.

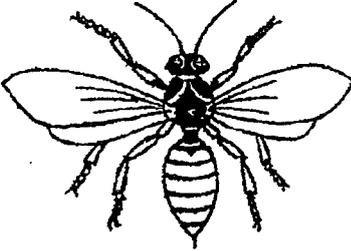
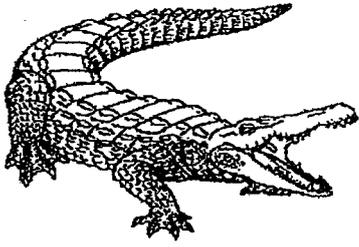
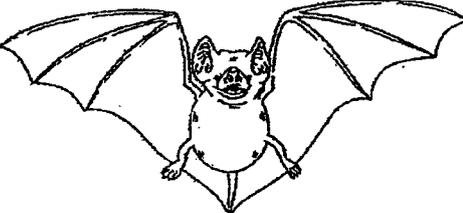
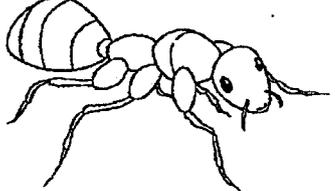
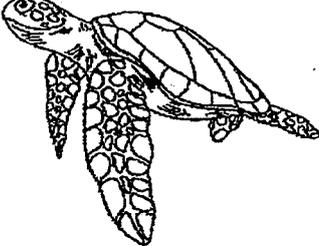
| Group E   | Group F  |
|---|--|
|    |    |
|    |    |
|  |  |

Which of the following characteristics of animals did Jane use to classify the animals?

- (1) number of legs
- (2) presence of tail
- (3) presence of wings
- (4) number of body parts

5. The table below shows the characteristics of four different living things, A, B, C and D. A tick (✓) means the living thing has the characteristic.

| Characteristic                          | A | B | C | D |
|---|---|---|---|---|
| It makes its own food.                  |   | ✓ |   | ✓ |
| It reproduces from seeds.               |   |   |   | ✓ |
| It responds to changes around it.       | ✓ | ✓ | ✓ | ✓ |
| It can only be seen using a microscope. | ✓ |   |   |   |

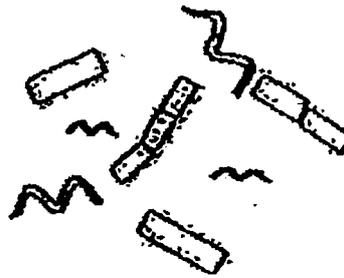

bacteria

From the table above, which of the living things, A, B, C or D, could be bacteria?

- (1) A
- (2) B
- (3) C
- (4) D

6. Study the classification chart below.

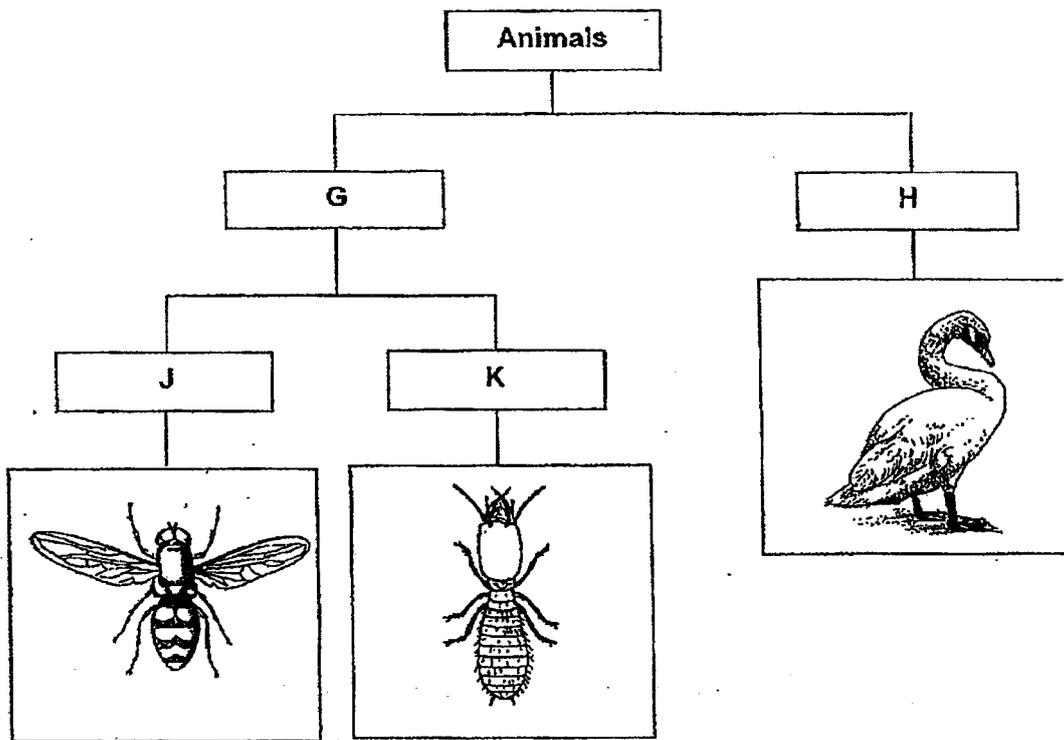

Which of the following are the correct headings for G, H, J and K?

|     | G                 | H            | J                 | K                 |
|-----|-------------------|--------------|-------------------|-------------------|
| (1) | No feathers       | Has feathers | Lays eggs         | Does not lay eggs |
| (2) | Six legs          | Two legs     | Has wings         | No wings          |
| (3) | No beak           | Has beak     | Does not lay eggs | Lays eggs         |
| (4) | Does not lay eggs | Lays eggs    | Has wings         | No wings          |

7. The life cycle of a flowering plant goes through stages X, Y and Z as shown in the diagram below.

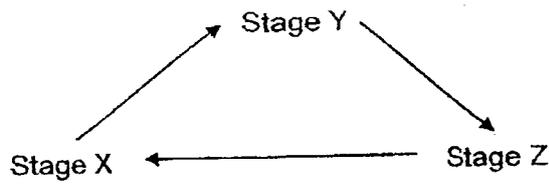

If stage X is the stage of the plant's life cycle where it has no roots yet, what is the name of stage Z of the life cycle?

- (1) egg
- (2) seed
- (3) adult plant
- (4) young plant

8. The diagram below shows the life cycle of an insect.

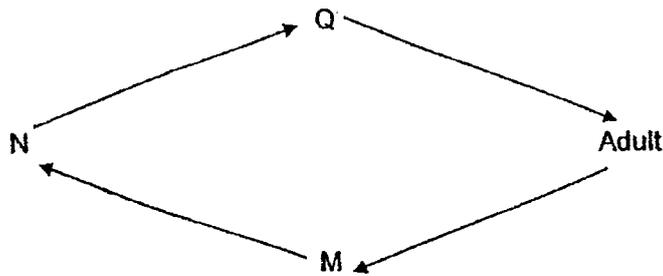

Which of the following shows the correct stages of its life cycle?

|     | M     | N     | Q     |
|-----|-------|-------|-------|
| (1) | Egg   | Pupa  | Nymph |
| (2) | Nymph | Pupa  | Egg   |
| (3) | Egg   | Larva | Pupa  |
| (4) | Pupa  | Larva | Egg   |

9. Which of the animals below has a life cycle that has a different number of stages from the rest?

(1)

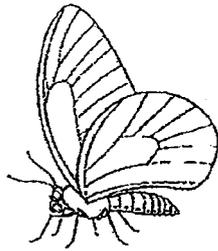

butterfly

(2)

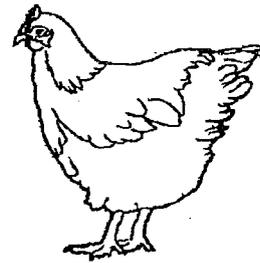

chicken

(3)

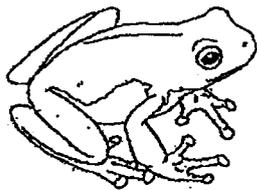

frog

(4)

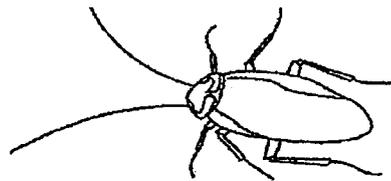

cockroach

10. Study the life cycles of animals, R and S below.

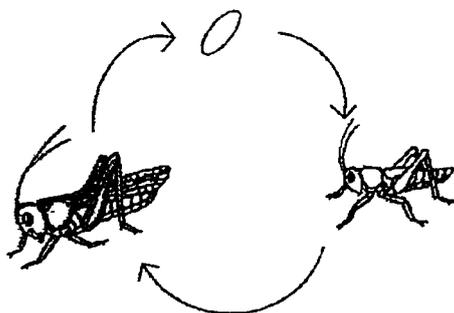

Life cycle of animal R

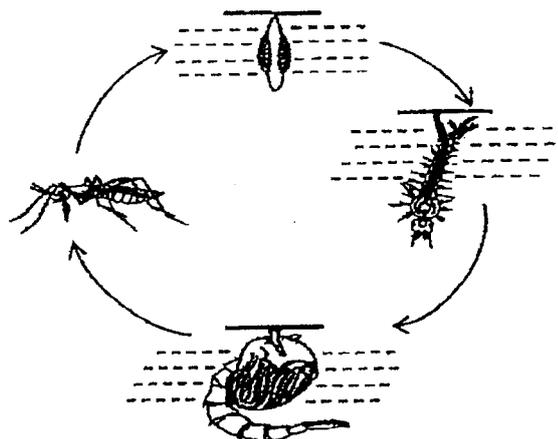

Life cycle of animal S

Which of the following is true of the life cycles shown above?

- (1) The young of animals, R and S, do not feed.
- (2) The young of animals, R and S, live in water.
- (3) Animal S has a pupal stage while animal R does not have a pupal stage.
- (4) The young of animal R does not look like the adult but the young of animal S does.

11. Abdul observed two animals, T and U, and completed the table as shown below. A tick (✓) means the animal has the characteristic.

| Observation                     | Animal T | Animal U |
|---------------------------------|----------|----------|
| It has three body parts.        |          | ✓        |
| Its young lives in water.       | ✓        |          |
| Its young looks like its adult. |          | ✓        |

Based on the table above, which of the following animals would most likely represent animals, T and U?

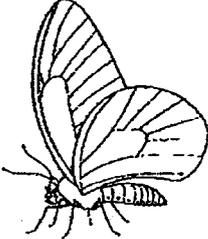
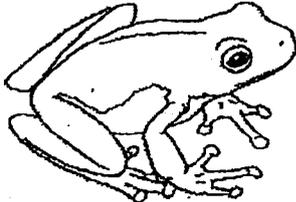
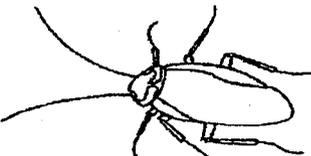
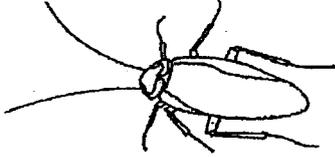
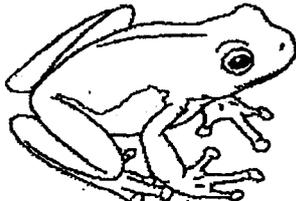
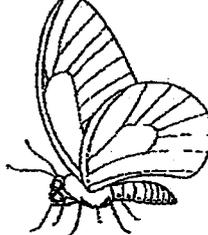
|     | Animal T  | Animal U   |
|-----|---|--|
| (1) |    |    |
| (2) |  |  |
| (3) |  |  |
| (4) |  |  |

12. The fireman wears the clothing as shown below when he puts out fires.



Based on the properties shown below, which material, A, B, C or D, is the most suitable for making the fireman's clothing?

|     | Material | Property |            |        |
|-----|----------|----------|------------|--------|
|     |          | flexible | waterproof | strong |
| (1) | A        | x        | x          | x      |
| (2) | B        | x        | ✓          | ✓      |
| (3) | C        | ✓        | ✓          | ✓      |
| (4) | D        | ✓        | x          | ✓      |

| Key |       |
|-----|-------|
| ✓   | : yes |
| x   | : no  |

13. Study the flowchart below.

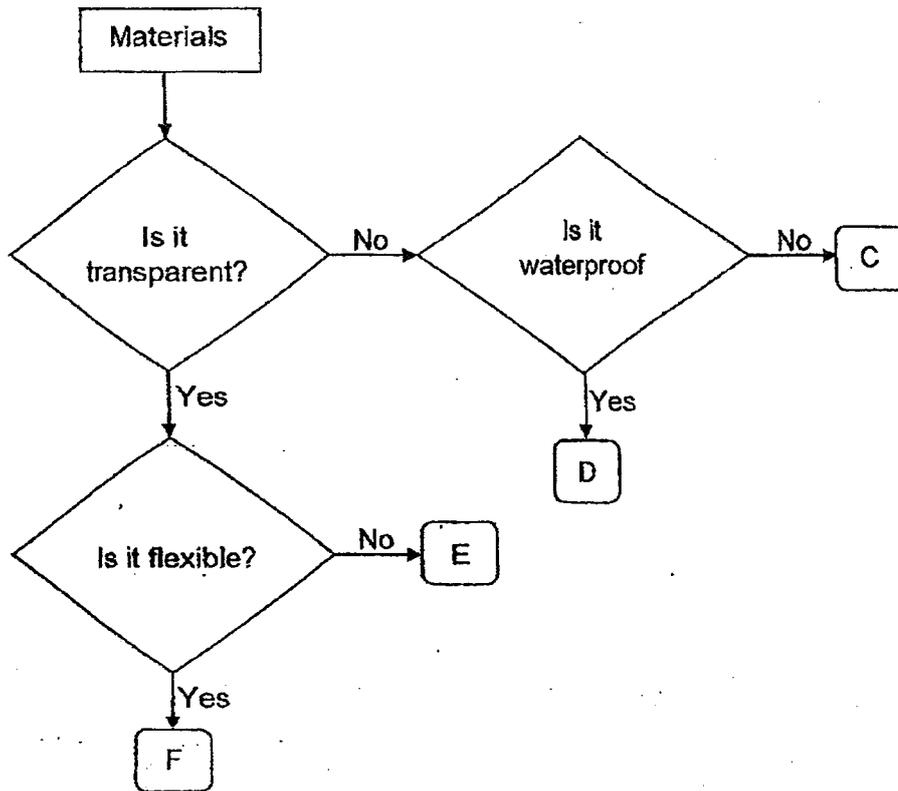

Based on the flowchart above, which of the following materials, C, D, E or F, is used to make the glass panel and metal door handle?

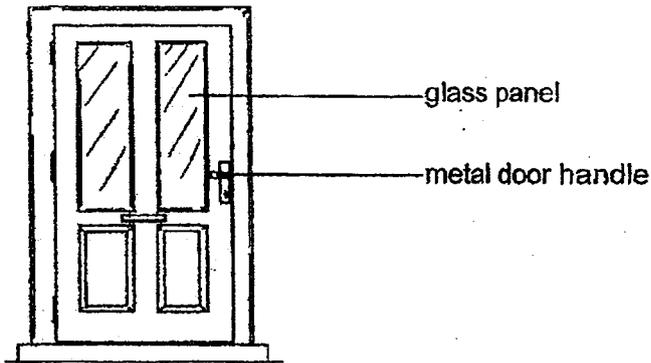

|     | glass panel | metal door handle |
|-----|-------------|-------------------|
| (1) | E           | D                 |
| (2) | F           | E                 |
| (3) | D           | C                 |
| (4) | C           | F                 |

14. Study the U-shaped magnet shown below.

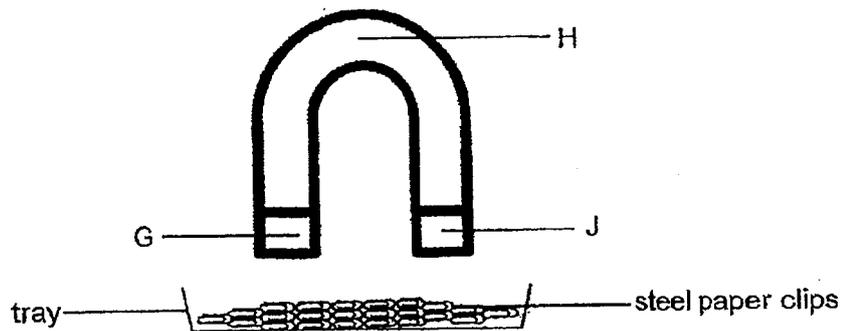

The magnet was placed in a tray of steel paper clips. Which of the following best represents the number of steel paper clips attracted to the parts, G, H and J?

|     | G  | H  | J  |
|-----|----|----|----|
| (1) | 5  | 10 | 5  |
| (2) | 10 | 5  | 10 |
| (3) | 10 | 10 | 10 |
| (4) | 10 | 10 | 5  |

15. Mrs Chan displayed a poster on the metal cabinet by placing object K on top of the poster.

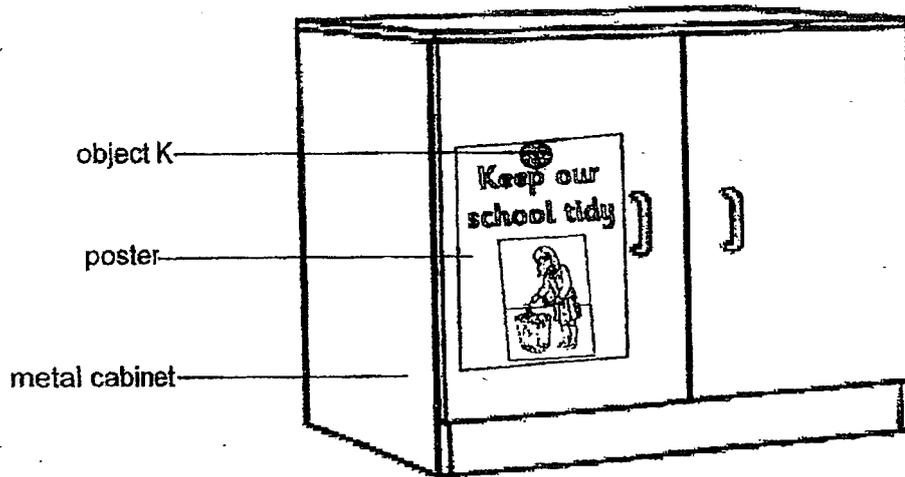

What can object K and the metal cabinet be made of?

|     | object K              | metal cabinet         |
|-----|-----------------------|-----------------------|
| (1) | magnet                | non-magnetic material |
| (2) | magnetic material     | magnetic material     |
| (3) | non-magnetic material | magnet                |
| (4) | magnet                | magnetic material     |

16. Study the set-ups below.

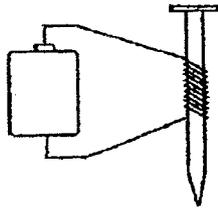

set-up P

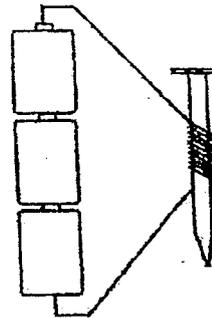

set-up Q

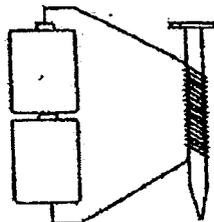

set-up R

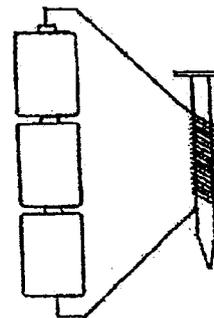

set-up S

Which of the following set-ups, P, Q, R or S, will have the greatest magnetic strength of attraction?

- (1) P
- (2) Q
- (3) R
- (4) S

17. Karen made a chess set as shown below. The chess board has a layer made of Material T. She then folded it as shown and observed if the chess pieces stay on the board.

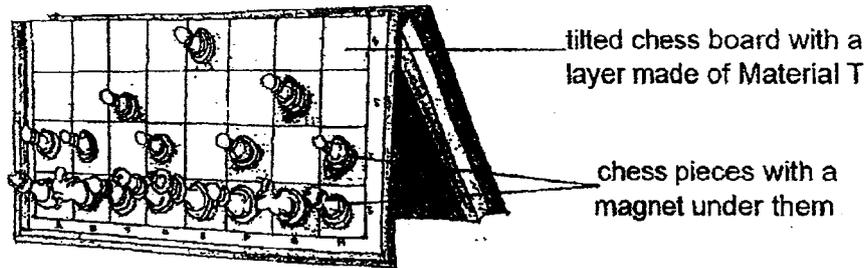

Karen tested the chess pieces again by replacing material T with materials, U, V and W, and recorded her observation in the table shown below.

| Material of chess board | Can the chess pieces stay on the board when it is folded? |
|-------------------------|---|
| T                       | Yes   |
| U                       | No  |
| V                       | No  |
| W                       | Yes   |

What could Karen infer from this observation?

- (1) Materials T and V are not made of metal.
- (2) Materials U and V are magnetic materials.
- (3) Materials V and W are non-magnetic materials.
- (4) Materials T and W can be attracted to a magnet.

End of Booklet A



## 2023 PRIMARY 3 END-OF-YEAR EXAMINATION

Name : \_\_\_\_\_ ( )

Date: 26 October 2023

Class : Primary 3 ( )

Time: 8.00 a.m. – 9.15 a.m.

Parent's Signature : \_\_\_\_\_

Duration: 1 hour 15 minutes

# SCIENCE

## BOOKLET B

### INSTRUCTIONS TO CANDIDATES

1. Write your name, class and register number.
2. Do not turn over this page until you are told to do so.
3. Follow all instructions carefully.
4. Answer all questions.
5. Write your answers in the booklet.

|           |    |
|-----------|----|
| Booklet A | 34 |
| Booklet B | 26 |
| Total     | 60 |

**Booklet B (26 marks)**

For questions 18 to 26, write your answers clearly in this booklet.

The number of marks available is shown in brackets [ ] at the end of each question or part question.

(26 marks)

18. The diagram below shows plant A in the wild.

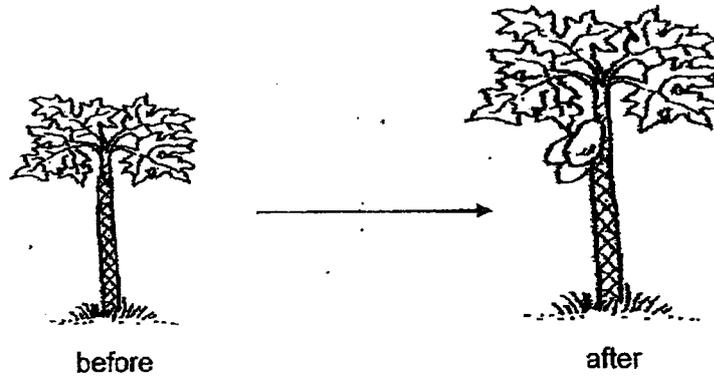

(a) Which characteristic of living things does plant A show? [1]

---

---

(b) The diagram below shows the cross section of the fruit of plant A. How are the seeds important to plant A? [1]

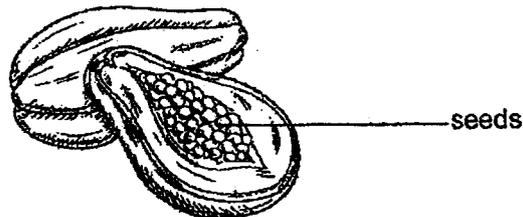

---

---

(c) It did not rain for months. What would happen to plant A? Explain why. [1]

---

---

|       |   |
|-------|---|
| Score | 3 |
|-------|---|

19. Sarah drew pictures of different stages of the life cycle of a plant. B, C and D are the different stages of the life cycle.

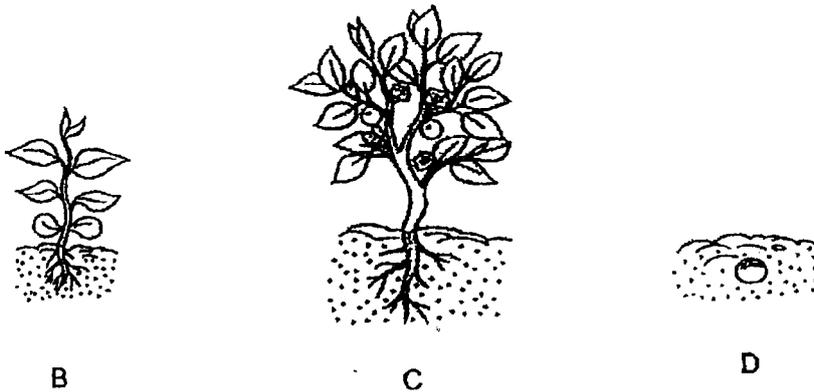

- (a) Using letters B, C and D, fill in the boxes to complete the life cycle of the plant. [1]

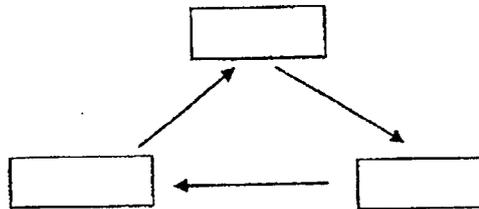

- (b) State one difference of a plant part that is shown in both stages B and C. [1]

---



---

- (c) Based on the pictures shown above, can you conclude this is a flowering plant? Explain why. [1]

---



---

|       |   |
|-------|---|
| Score | 3 |
|-------|---|

20. Study the flowchart below.

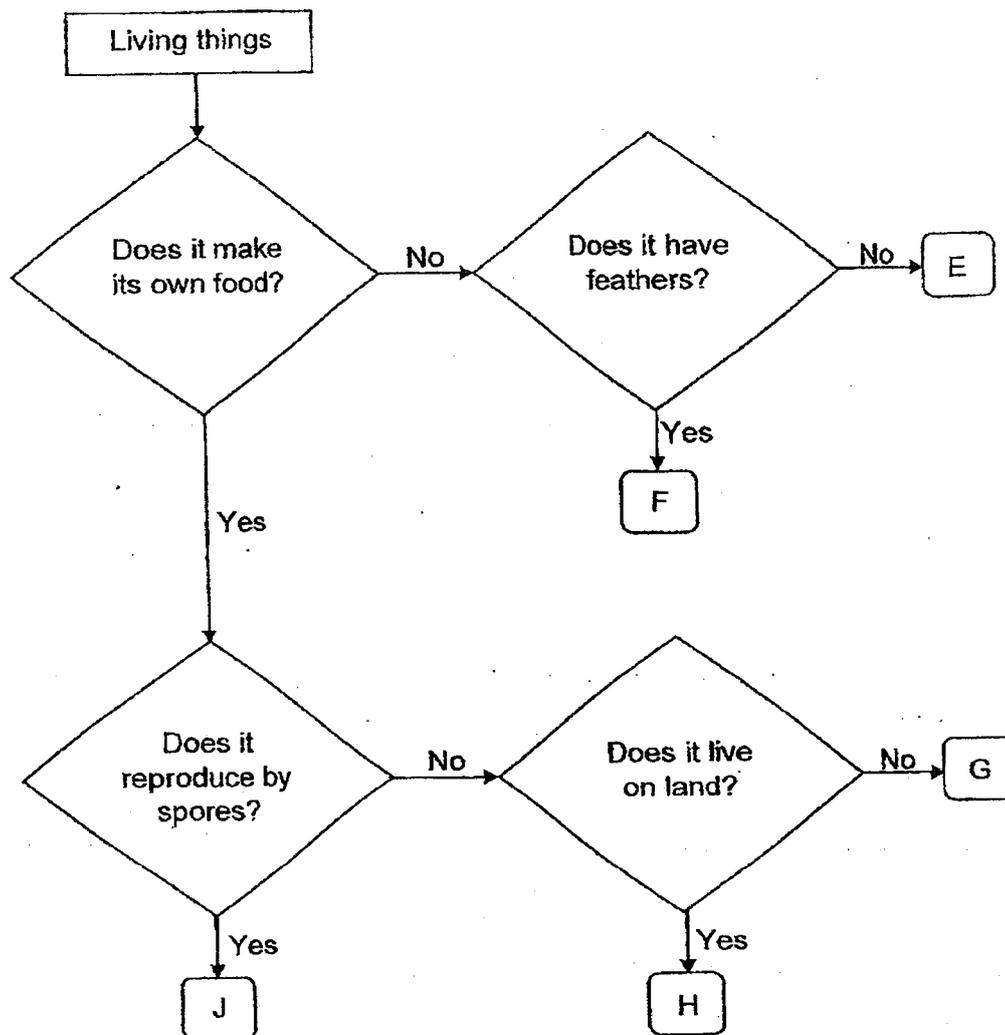

(a) Based on the flowchart, state the difference between living things, H and J. [1]

---

---

|       |   |
|-------|---|
| Score | 1 |
|-------|---|

- (b) Based on the flowchart, write the letters, E, F, G, H or J, that represent the living things shown in the pictures below. [1]

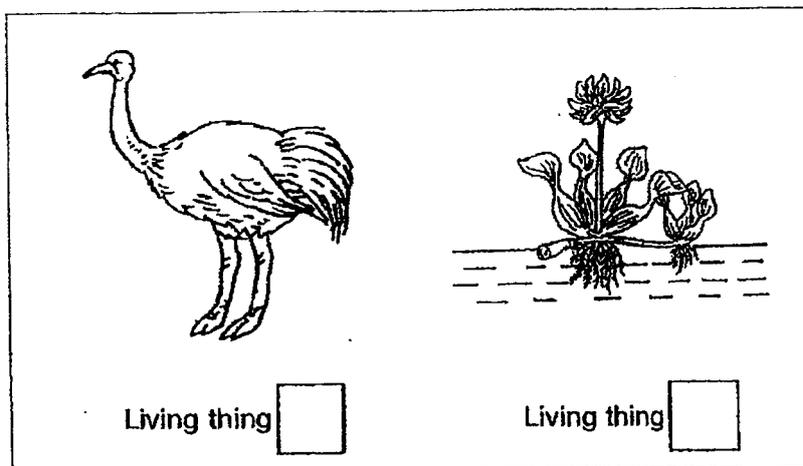

The diagram below shows plant K.

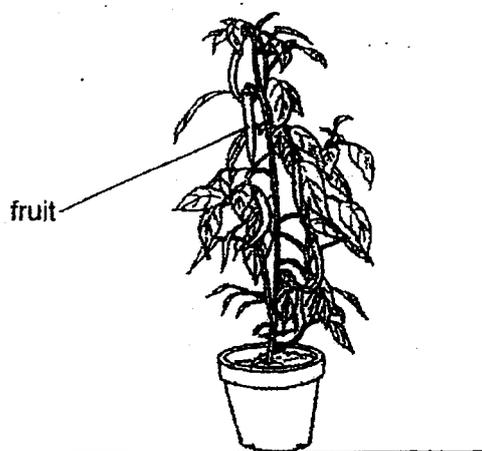

- (c) Based on the flowchart, can 'G' be plant K? Explain why. [1]

---

---

|       |   |
|-------|---|
| Score | 2 |
|-------|---|

21. Kumar conducted an experiment on mealworm beetles. He recorded the amount of food eaten in each stage of its life cycle in the graph below. R, S, egg and adult are the different stages in its life cycle.

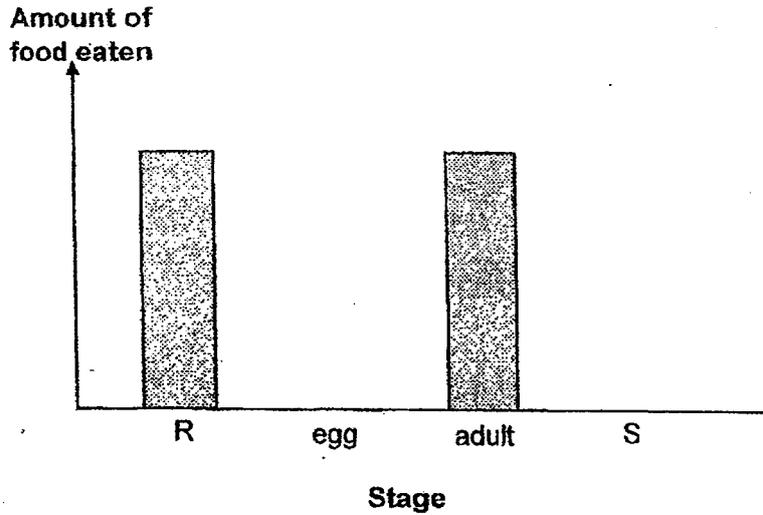

- (a) Based the information from the graph, at which stage, R or S, is the mealworm beetle a larva? Explain why. [1]

---



---

- (b) Based on the graph above, fill in the boxes below with the letters, R or S, to complete the life cycle of the mealworm beetle. [1]

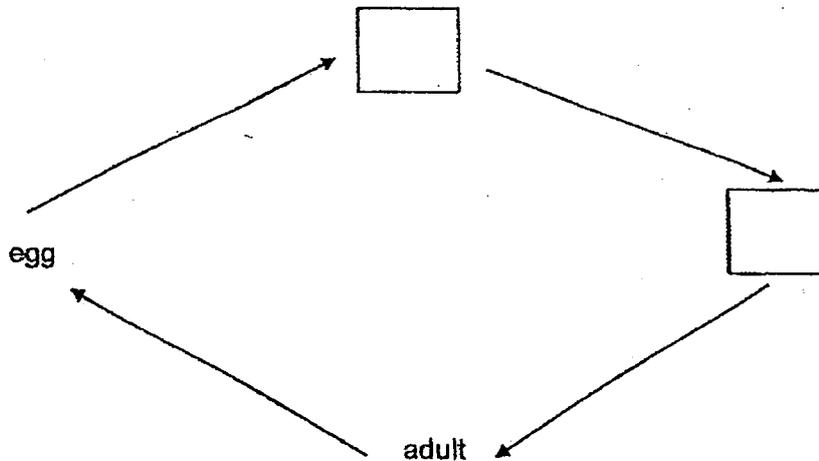

|       |   |
|-------|---|
| Score | 2 |
|-------|---|

Mealworm beetles are pests as they feed on plants. The diagrams below show a mealworm beetle and its larva.

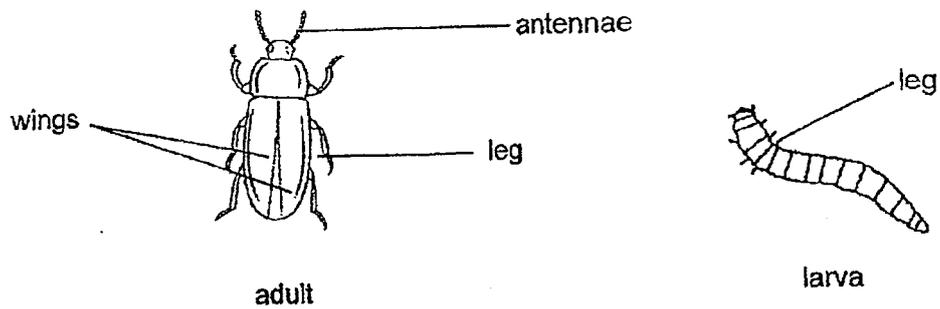

(c) Using a characteristic from the diagrams above, explain why it is more difficult to get rid of the adult than the larva? [1]

---

---

|       |   |
|-------|---|
| Score | 1 |
|-------|---|

22. Alvin placed three different materials, P, U and V, into three identical containers containing 500 ml of water each. The materials are of the same shape, size, and thickness, as shown in the diagrams below.

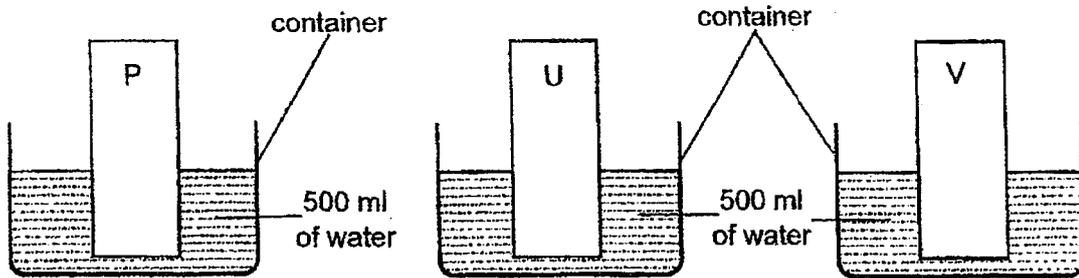

After five minutes, he removed the three materials. The table below shows the amount of water left in the containers.

| Material | Amount of water left in the container (ml) |
|----------|--|
| P        | 200  |
| U        | 0  |
| V        | 500  |

- (a) Arrange the three materials, P, U and V, in order of its ability to absorb water. [1]

|  |  |  |
|--|--|--|
|  |  |  |
|--|--|--|

does not absorb water at all → absorbs the most water

The diagram below shows a beach ball.

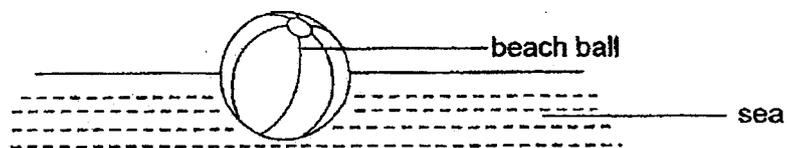

- (b) Apart from being waterproof, what other property must a beach ball have as shown above? [1]

---



---

|       |   |
|-------|---|
| Score | 2 |
|-------|---|

23. Celine wanted to compare the flexibility of three different materials of same size and length, W, X and Y. She hung a 500 g weight on each sheet of material using an identical string and observed how much the material bent.

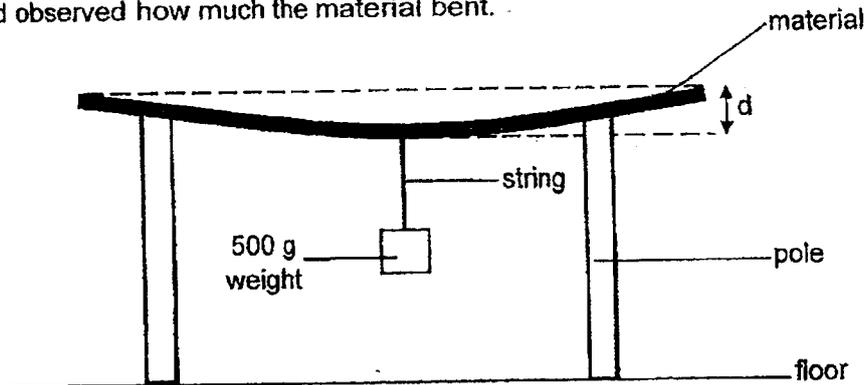

She then measured the distance,  $d$ , shown above and recorded the results in the table below.

| Material | Distance, $d$ (cm) |            |           |
|----------|--------------------|------------|-----------|
|          | First Try          | Second Try | Third Try |
| W        | 1                  | 1          | 1         |
| X        | 10                 | 8          | 12        |
| Y        | 7                  | 5          | 6         |

- (a) Based on Celine's experiment, which material, W, X or Y, is the most flexible? Explain your answer. [1]

---



---

The diagram below shows a basket with some books.

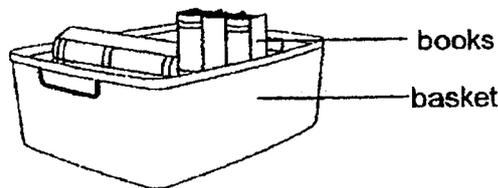

- (b) Based on Celine's experiment, which material, W, X or Y, is the most suitable for making the basket? Explain your answer. [1]

---



---

|       |   |
|-------|---|
| Score | 2 |
|-------|---|

24. Dan set up an experiment as shown below.

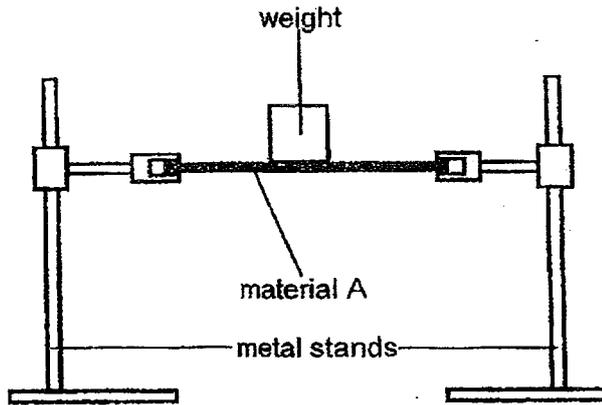

Weights of different mass were placed on material A until the material broke. The experiment was then repeated with different materials, B and C. The results were shown in the table below.

| Material | Mass needed for the material to break (kg) |
|----------|--|
| A        | 10   |
| B        | 35   |
| C        | 50   |

(a) What property of material was Dan trying to test?

[1]

---

(b) Tick (✓) the variable(s) that must be kept the same to make the experiment a fair test.

[1]

| Variable              | Variable(s) that must be kept the same |
|-----------------------|--|
| type of material      |  |
| length of material    |  |
| thickness of material |  |

|       |   |
|-------|---|
| Score | 2 |
|-------|---|

Dan wants to make a hammock using material B so that he can sleep on it as shown below.

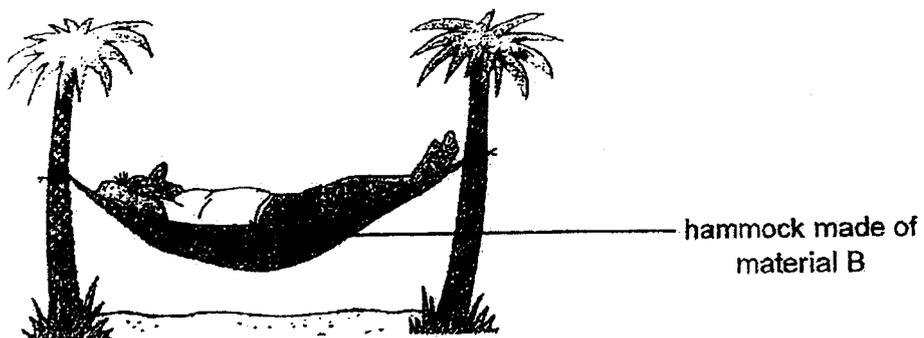

(c) Dan's mass is 37 kg. Would it be safe for him to sleep on the hammock? Explain why. [2]

---

---

|       |   |
|-------|---|
| Score | 2 |
|-------|---|

25. Siti makes four magnets, K, L, M and N, using the stroking method.

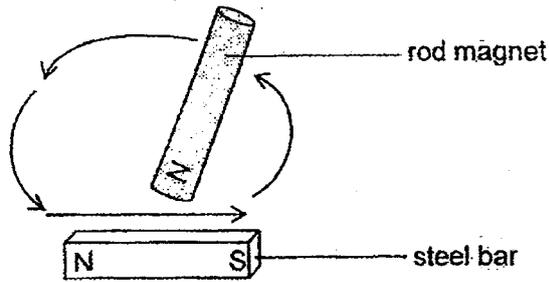

She used these magnets to attract some iron pins as shown below.

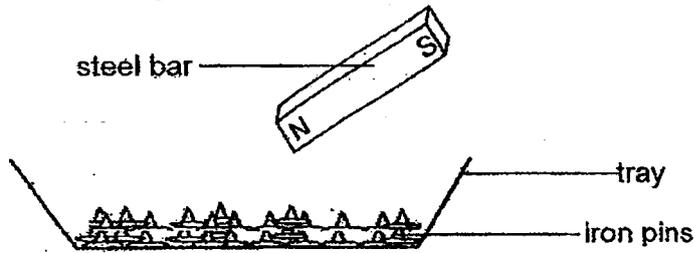

She recorded her observations in the table below.

| Bars | Number of strokes | Number of iron pins attracted |
|------|-------------------|-------------------------------|
| K    | 20                | 2                             |
| L    | 30                | 6                             |
| M    | 40                | Y                             |
| N    | 50                | 14                            |

(a) Based on the results above, what is the likely value of Y? [1]

---

(b) What can Siti conclude about the relationship between the number of strokes and the magnetic strength of the steel bar? [1]

---



---

|       |   |
|-------|---|
| Score | 2 |
|-------|---|

Siti attached the steel bar K on the duster as shown below. When the duster was placed on the whiteboard, it kept sliding down.

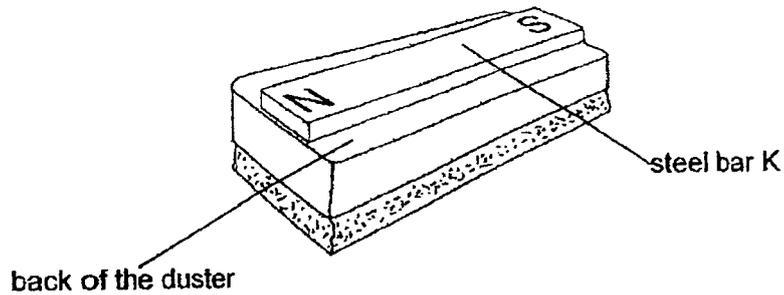

(c) Which bar, L, M or N, should she replace so that the duster will least likely slide down the whiteboard? Explain why. [1]

---

---

|       |   |
|-------|---|
| Score | 1 |
|-------|---|

26. The diagram below shows a toy train E being pulled towards magnet X quickly after it is released a distance away from magnet X.

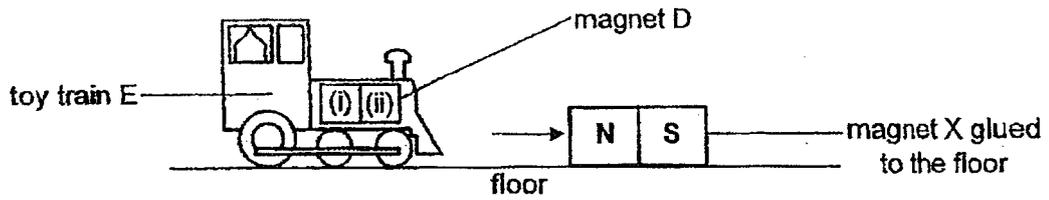

- (a) Fill in the blanks, (i) and (ii), with 'N' and 'S' to represent the poles of magnet D. [1]

(i): \_\_\_\_\_ (ii): \_\_\_\_\_

- (b) Explain why toy train E is pulled towards magnet X. [1]

---



---

Kim Yong brought toy train E close to toy train F as shown below. Toy train F did not move at all.

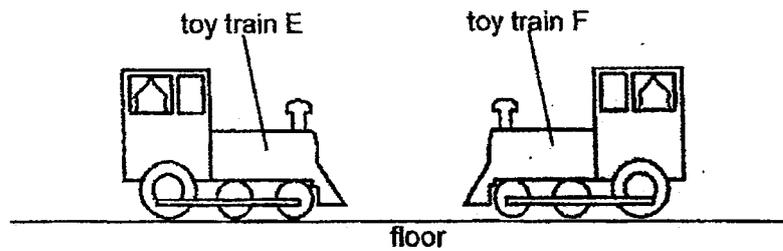

- (c) Explain why toy train F did not move at all. [1]

---



---

|       |   |
|-------|---|
| Score | 3 |
|-------|---|

End of Booklet B



SCHOOL : TAONAN PRIMARY SCHOOL  
 LEVEL : PRIMARY 3  
 SUBJECT : SCIENCE  
 TERM : 2023 SA2

CONTACT :

**BOOKLET A**

| Q1  | Q2  | Q3  | Q4  | Q5  | Q6  | Q7  | Q8 | Q9 | Q10 |
|-----|-----|-----|-----|-----|-----|-----|----|----|-----|
| 4   | 4   | 4   | 3   | 1   | 2   | 3   | 3  | 1  | 3   |
| Q11 | Q12 | Q13 | Q14 | Q15 | Q16 | Q17 |    |    |     |
| 2   | 3   | 1   | 2   | 4   | 4   | 4   |    |    |     |

**SECTION B**

|      |  |
|------|--|
| Q18) | <p>(a) Living things can grow</p> <p>(b) The seeds help Plant A to reproduce/grow into plants or Seeds help Plant A to continue its own kind to live on Earth.</p> <p>(c) Plant A died as it did not have enough water to survive</p>  |
| Q19) | <div style="text-align: center;"> <pre> graph TD     C[C] --&gt; B[B]     C[C] --&gt; D[D]     D[D] --&gt; B[B]           </pre> </div> <p>(a)</p> <p>(b) The plant in stage C has flowers/fruits but the plant in stage B does not Or<br/>         The Plant in stage C has longer/deeper roots than the plant in stage B Or<br/>         The plant in stage C has longer/thicker/taller stem than the plant in stage B</p> <p>(c) Yes. It has fruits/seeds/flowers</p> |
| Q20) | <p>(a) J reproduces by spores but H does not.</p>  |

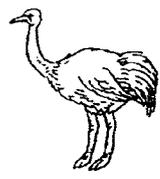
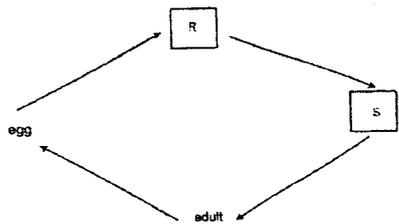
|                       | <div style="display: flex; justify-content: space-around; align-items: center;">   </div> <p>(b) Living thing <span style="border: 1px solid black; padding: 0 5px;">F</span>      Living thing <span style="border: 1px solid black; padding: 0 5px;">G</span></p> <p>(c) No. Plant K grows on land but G does not</p>   |          |  |                  |  |                    |   |                       |   |
|-----------------------|---|----------|--|------------------|--|--------------------|---|-----------------------|---|
| Q21)                  | <p>(a) Stage R. Larva eats a lot and there is food eaten at stage R but not at stage S</p> <div style="text-align: center;">  </div> <p>(b)</p> <p>(c) The adult has wings while the larva does not have wings so the adult can fly or .</p> <p>The adult can crawl/move faster than the larva as it has longer legs.</p>  |          |  |                  |  |                    |   |                       |   |
| Q22)                  | <div style="text-align: center;"> <table border="1" style="margin: 0 auto;"> <tr> <td style="width: 33%; text-align: center;">V</td> <td style="width: 33%; text-align: center;">P</td> <td style="width: 33%; text-align: center;">U</td> </tr> </table> <p>does not absorb water at all <span style="font-size: 2em;">→</span> absorbs the most water</p> </div> <p>(a)</p> <p>(b) The beach ball floats on water/ has the ability to float.</p>  | V        | P                                      | U                |  |                    |   |                       |   |
| V                     | P   | U        |  |                  |  |                    |   |                       |   |
| Q23)                  | <p>(a) X. X bends the most. D is the largest when hanging the same amount of weight on it.</p> <p>(b) W. W is the least flexible so the basket with books will bend the least<br/>Or hold the books properly.</p>   |          |  |                  |  |                    |   |                       |   |
| Q24)                  | <p>(a) strength or How strong the material is</p> <table border="1" style="margin: 0 auto;"> <thead> <tr> <th style="text-align: center;">Variable</th> <th style="text-align: center;">Variable(s) that must be kept the same</th> </tr> </thead> <tbody> <tr> <td style="text-align: center;">type of material</td> <td></td> </tr> <tr> <td style="text-align: center;">length of material</td> <td style="text-align: center;">✓</td> </tr> <tr> <td style="text-align: center;">thickness of material</td> <td style="text-align: center;">✓</td> </tr> </tbody> </table> <p>(b)</p> | Variable | Variable(s) that must be kept the same | type of material |  | length of material | ✓ | thickness of material | ✓ |
| Variable              | Variable(s) that must be kept the same  |          |  |                  |  |                    |   |                       |   |
| type of material      |   |          |  |                  |  |                    |   |                       |   |
| length of material    | ✓   |          |  |                  |  |                    |   |                       |   |
| thickness of material | ✓   |          |  |                  |  |                    |   |                       |   |

|      |  |
|------|--|
|      | <p>(c) No. Material B can only hold up to 35 kg but Dan is more than 35 kg. So the hammock will break when he sleeps on it OR injure himself Or he will fall.</p>  |
| Q25) | <p>(a) Any number from 7 to 13</p> <p>(b) The more the number of strokes, the stronger the magnetic strength of the steel bar.</p> <p>(c) Steel Bar N. It is able to attract the most iron pins.</p> <p>Or It has the strongest/highest magnetic strength.</p>   |
| Q26) | <p>(a) (i) N            (ii) S</p> <p>(b) Unlike poles of magnets D and X are facing each other. So they are attracted to each other.</p> <p>(c) Toy train F is made of a non-magnetic material. So it is not attracted/repelled (by toy train E)</p> <p>OR</p> <p>Toy train F has no magnet inside. So it is not attracted/repelled by Toy train E.</p> |

